



About...

HAENIM TOY

Established in 1967, HAENIM TOY is a leading brand from Korea that produces more than 110 types of items of baby products based on injection molding technology and product planning capability. HAENIM TOY is the only company in Korea that supplies a variety of products to Target and Toys r us in the US. HAENIM TOY have been supplying ODM products to the world's leading toy companies and are currently expanding their local marketing and exporting business in Asian regions through the popularity of Korean childcare programs in Southeast Asia.

- 1969.05** Established Dongsin Chemistry Co.,Ltd.
- 1994.04** Acquired Q-mark by Korean living supplies. (Quality assurance company)
- 1994.10** Purchased the second factory
(Area : 1,060py, Building space : 1,600py, Shinpyung Dong, Sahagu, Busan)
- 1995.11** Awarded US \$ 5million export tower
- 1998.06** Acquired GQ mark as superior products of small and medium company
- 1999.01** Changed company name of dongsin Chemistry Co.,Ltd to HAENIMTOY Co.,Ltd

- 2001.03** Moved to Noksan National Industrial Complex (Area : 10,200py, Building space : 8,500py)
- 2002.10** Established research institute affiliated to Haenim Toys
- 2003.04** Acquired ISO 9001 Certification
- 2003.12** Opened Haenim kindergarten
- 2005.07** Acquired FSO / TS16946 : 2006 Certificate (CERMET)
- 2006.07** Established HanEx Co.,Ltd as a Research institute affiliated to Haenim Toys
- 2009.12** Selection of the world-class product (Electric toys for riding)

- 2012.05** Launch in domestic open markets and general shopping malls
- 2012.10** The headquarters opened online shopping mall
- 2014.02** Selected as IP Star Industry (Busan Knowledge Center)
- 2014.12** Certified as a leading company in one of Busan Metropolitan City Government's strategic industries (2015)
- 2015.09** Certified as company for Excellence in Employee Invention Promotion from the Korean Intellectual Property Office
- 2017.12** Certified as a leading company in one of Busan Metropolitan City Government's strategic industries (2018)
- 2018.01** Established a haenim color laboratory
- 2018.05** Launched Carrie Friends and Disney licensed products.

Contents

12



28



47



56



60



66



| BABY ROOM

- 08 Petit Baby Room
- 12 Signature Baby Room
- 16 Character Baby Room
- 20 Application
- 22 Signature & Petit Folder Mat

| PLAY GyMS

- 28 Kids House / My First Playhouse
- 30 Kids House with Slide / Fun Park Kids Playhouse
- 32 Dolphin Slide / Dolphin Play Zone
- 34 Little Slide / Little Castle
- 36 Kids Play Zone / Kingdom Play Zone
- 38 My First Activity Slide
- 39 Mini Coco Slide
- 40 Kidzone / Play House with a Swing
- 41 Little Play House / Super Play House with a Swing
- 42 House Slide / Toddler Slide
- 43 Popo Swing (Single / Double)

| BLOCKS

- 47 Macaron Big Block
- 49 Carrie Big Block
- 50 Crayon Block
- 52 Baby Block

| CARS

- 56 Carrie My Car
- 57 Royal Car (Single / Double) / Dolphin Seesaw / Rocking Pony

| BABY PRODUCTS

- 60 Baby Bathtub / Baby Bath Bed
- 61 Bio Trainer / Potty Plus Leo
- 62 Baby Bath Chair / Aga Bed
- 63 Sunny Swing Bed / New Huggies Bed

| DESK & CHAIR

- 66 Single Desk & chair set
- 67 Double Desk & chair set
- 68 Kids Play & Picnic Table / Bear Chair

CHARACTER ZONE

- 69 Carrie Friends
- 72 Disney tsum tsum



Size L 1210 × W 1210 × H 600 mm | **Box Size** L 765 × W 257 × H 625 mm | **Weight** 7.0 kg | **Material** PE/PP | **Age** Over 6months

PETIT BABY ROOM

This Petit baby room is designed to meet the level of baby's view with it right sized for baby and it provides baby with emotional stability while playing in the baby room. Three modern and artistic colors; gray+white, pink+white, and blue+white, provide perfect combinations for interior in your house. It is easy to assemble with each wall interlocked without any additional connectors and features the round molded design for safety.

Color



Gray&White



Pink&White



Blue&White

Option 1

PETIT BABY ROOM With Activity Center

HNP-737-D1A1W1G3

Door Wall 1ea | White Wall 1ea | Gray Wall 3ea | Activity Wall 1ea



The fun activity wall including phones, gears, windows and spinning balls provides hours of fun. Kids will love talking on the phone and setting the gears in motion.

Option 2

PETIT BABY ROOM Basic

HNP-737-D1W2G3

Door Wall 1ea | White Wall 2ea | Gray Wall 3ea



The round molded design enhances safe play for kids and the lovely characters on the walls keep kids staying inside.



Add a wall to your basic petit-baby room to create a more spacious and diverse baby room.

Optional Extension Kit

- The petit baby room can be extended by adding each basic wall, wide wall, door wall and activity wall.
- The activity wall will stimulate curiosity while enhancing concentration.
- Features a wall lock to be seated between two wall panels to minimize the shaking of the wall panels.
- The additional Non-slip kit such as non-slip pad, wall lock and silicon pad to minimize the slipping and shaking of the walls for more stable and steady baby room.

Basic Wall



White



Gray



Pink



Blue

Wide Wall



White



Gray



Pink



Blue

Etc



Door Wall (Gray)



DoorWall (Pink)



Activity Wall

※ Colors may vary

Features



Double door lock system does not allow kids to open the door from inside.



All the corners are designed to round molded end for safety.



The square rubber pads are helpful to minimize the slipping of the walls.

Non-slip Kit

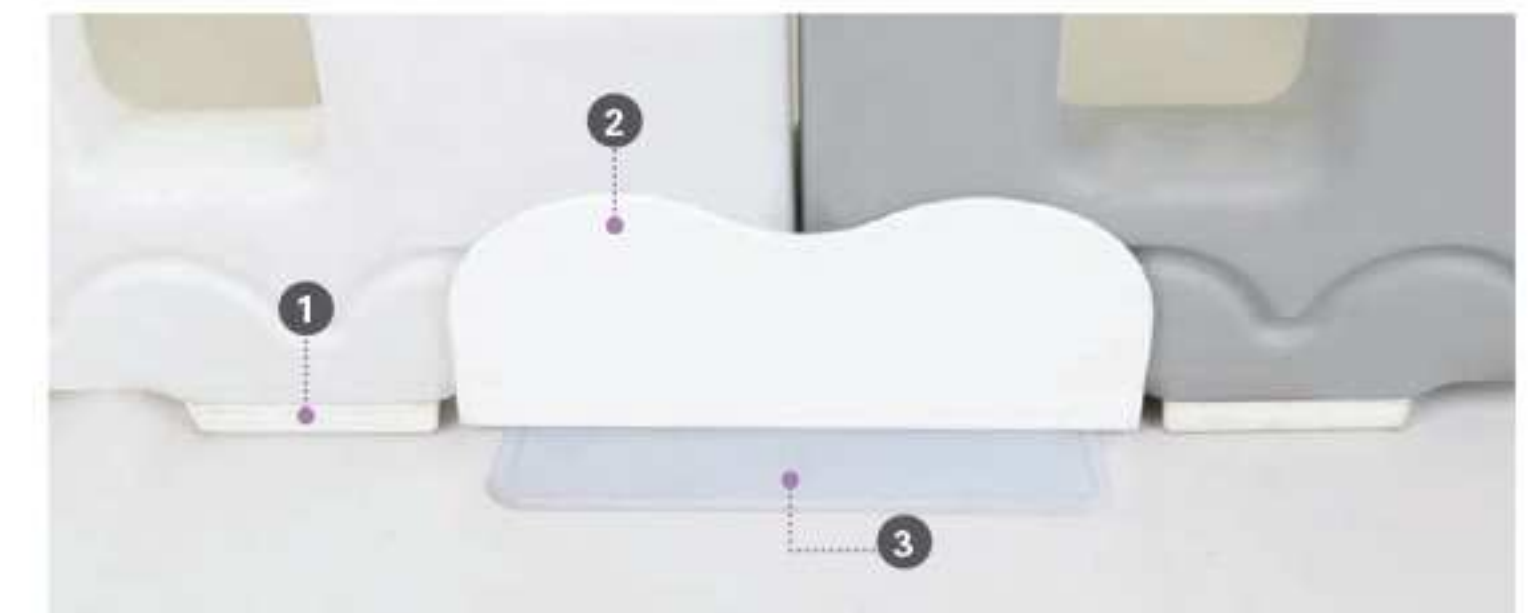



Petit baby room H 600 X W 750mm / 1pc	Signature baby room H 600 X W 800mm / 1pc	Character baby room H 650 X W 850mm / 1pc

HAENIM TOY BABY ROOM LINE

Size L 1160 x W 1160 x H 610 mm | **Box Size** L 820 x W 270 x H 630 mm | **Weight** 8.95 kg | **Material** PE/PP | **Age** Over 6months

SIGNATURE BABY ROOM

This Signature baby room helps babies develop their 5 senses while playing with 5 different playset in activity wall and kids favorite melodies and lights in the melody keyboard. Safe playzone for kids will provide mothers with peace and rest. The lovely colors of beige, deep blue, yellow and blue will inspire kids to build up their cognitive and emotional development. Double door lock system and round molded end are generated from our design value of "the First Priority of Safety for Kids." Various shapes with different combinations of walls allow you to create your own playzone.

Color



Option 1

SIGNATURE BABY ROOM With Activity center

HNP-734

Door Wall 1ea Basic Wall 2ea Activity Wall 1ea



The fun activity wall including phones, gears, windows and spinning balls provides hours of fun. Kids will love talking on the phone and setting the gears in motion.

Option 2

SIGNATURE BABY ROOM Basic

HNP-734N

Door Wall 1ea Basic Wall 3ea

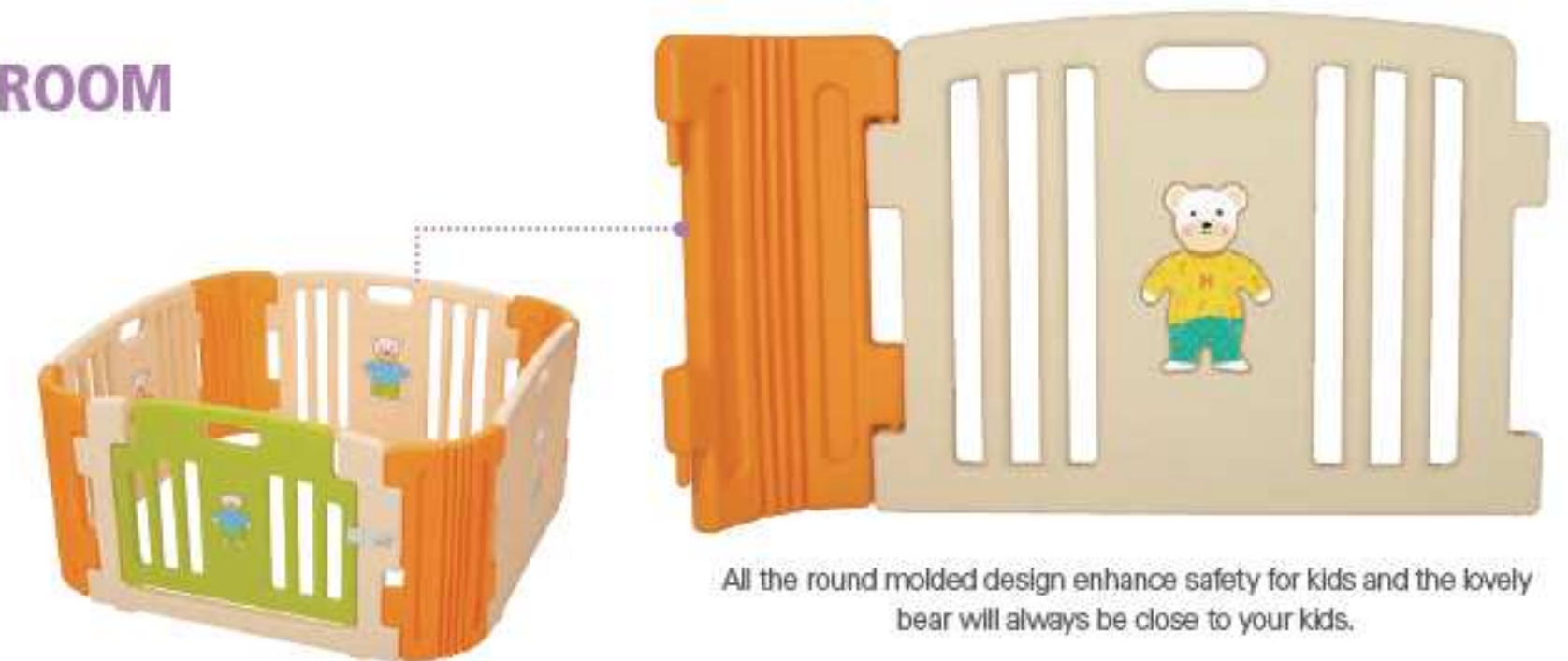

All the round molded design enhance safety for kids and the lovely bear will always be close to your kids.

Option 3

SIGNATURE BABY ROOM With Melody

HNP-734M

Door Wall 1ea Basic Wall 2ea Melody Wall 1ea

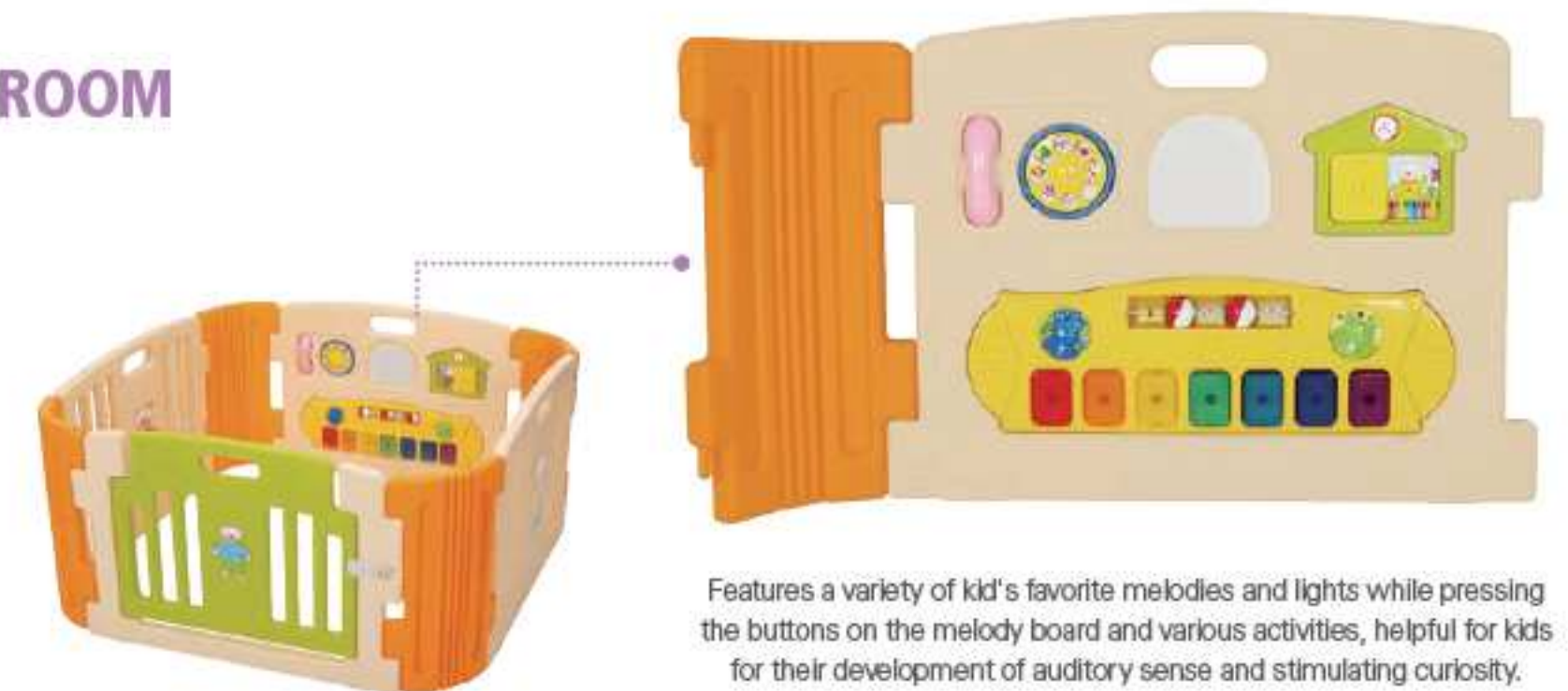

Features a variety of kid's favorite melodies and lights while pressing the buttons on the melody board and various activities, helpful for kids for their development of auditory sense and stimulating curiosity.



Optional Extension Kit

- The baby room can be extended by adding each basic wall, wide wall, door wall and activity wall.
- The activity wall and melody wall will stimulate curiosity while enhancing concentration.
- Features a wall lock to be seated between two wall panels to minimize the shaking of the wall panels.

Add a wall to your basic baby room to create a more spacious and diverse baby room.

Features



Double door lock system does not allow kids to open the door from inside.



Features flexible corner wall.

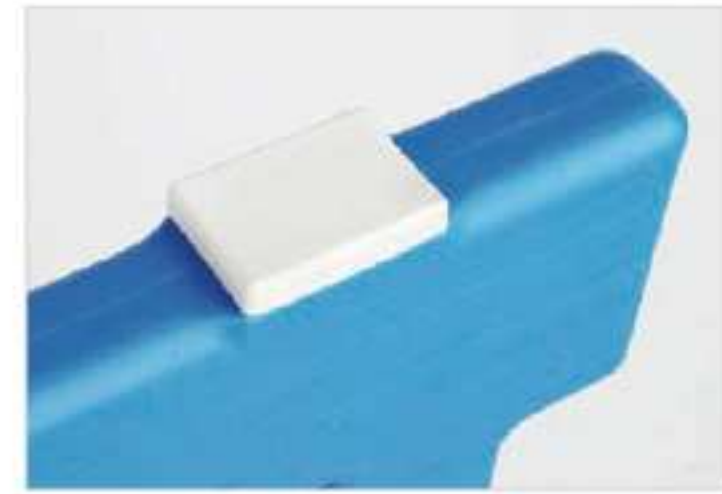

The square rubber pads are helpful to minimize the slipping of the walls.



Features a variety of kid's favorite melodies and lights and various activities, helpful for kids for their development of auditory sense and stimulating curiosity.

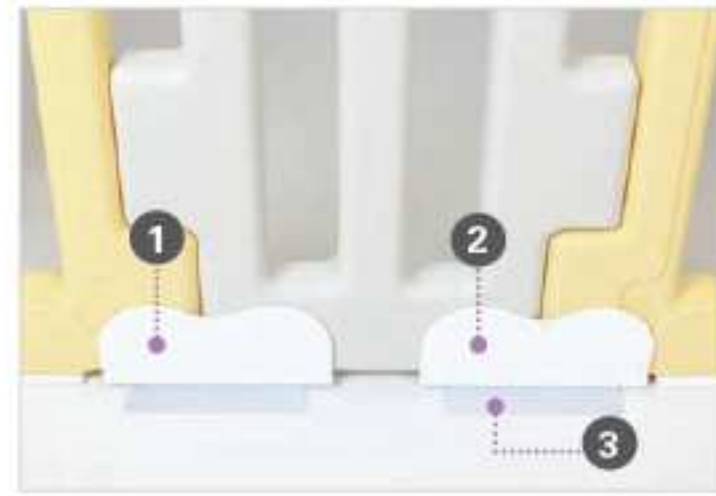

The additional Non-slip kit such as non-slip pad, wall lock and silicon pad to minimize the slipping and shaking of the walls for more stable and steady baby room.



Basic Wall



Beige



Deep Blue



Blue



Yellow

Activity Wall



Beige



Red



Blue



Yellow

Melody Wall & Keyboard



Beige



Red



Melody Keyboard

Door Wall



Beige



Deep Blue



Blue



Yellow

Flat Connector



Orange



Yellow



Gray

Non-Slip Kit



Wall Lock



Non-slip Pad



Silicon Pad

※ Colors may vary



CHARACTER BABY ROOM With Activity Center

HNP-734C

- Door Wall 1ea
- Basic Wall 2ea
- Activity Wall 1ea



The fun activity wall including phones, gears, windows and spinning balls provides hours of fun. Kids will love talking on the phone and setting the gears in motion.

- Size**
L 1160 x W 1270 x H 650 mm
- Box Size**
L 930 x W 278 x H 678 mm
- Weight**
9.00 kg
- Material**
PE/PP
- Age**
Over 6months

CHARACTER BABY ROOM

Character baby room is designed to generate the childlike delight and embody the sophisticated comfort expected of a world-class brand on its wall design. Safe playzone for kids will provide mothers with peace and rest. Double door lock system and round molded end are generated from our design value of "the First Priority of Safety for Kids." Wide walls allow you to create spacious playzone.

Color



NEW Blue



NEW Yellow



Petit baby room H 600 X W 750mm /1pc
Signature baby room H 600 X W 800mm /1pc
Character baby room H 650 X W 850mm /1pc

SIGNATURE BABY ROOM vs CHARACTER BABY ROOM

SIGNATURE BABY ROOM BASIC WALL



CHARACTER BABY ROOM BASIC WALL

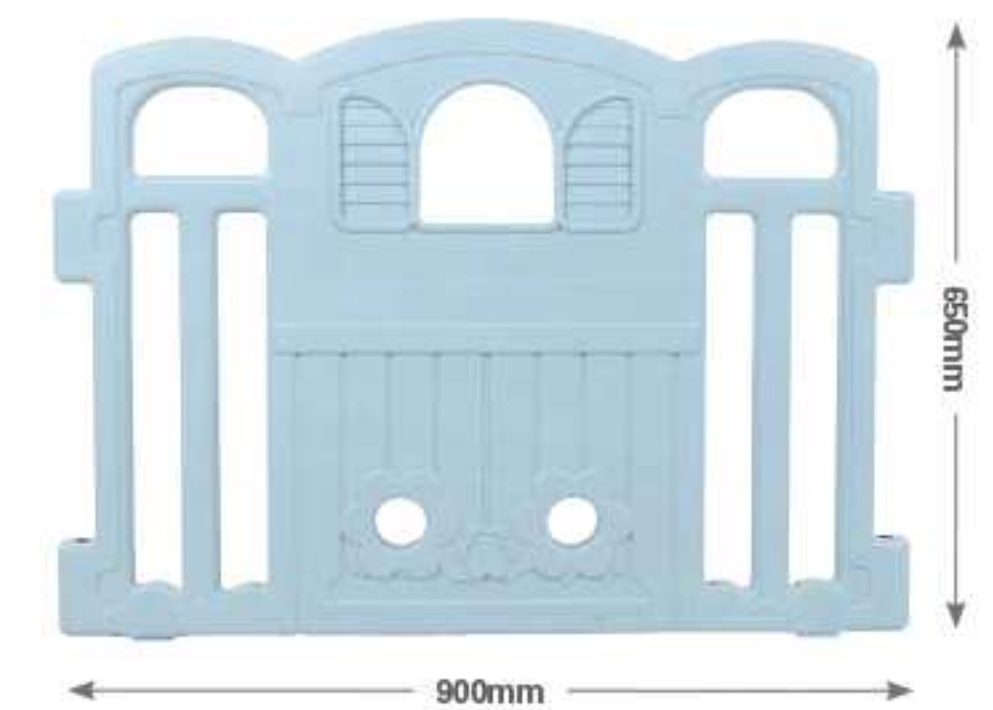

Character baby room comes with 2 more bigger walls than other standard walls by 100mm in width and 50mm in height.



Add a wall to your basic baby room to create a more spacious and diverse baby room.

Features



Double door lock system does not allow kids to open the door from inside.



Adorable character pictures are appealing and offer stability to the child. Character pictures can be changed upon request.



The square rubber pads are helpful to minimize the slipping of the walls.



Features a variety of kid's favorite melodies and lights and various activities, helpful for kids for their development of auditory sense and stimulating curiosity

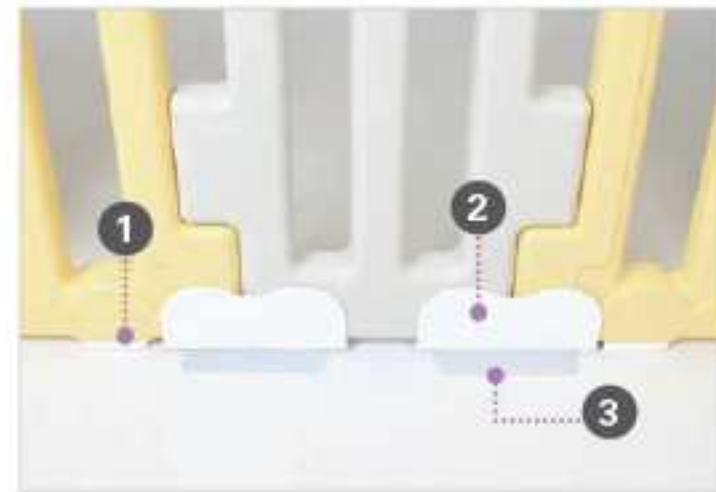

The additional Non-slip kit such as non-slip pad, wall lock and silicon pad to minimize the slipping and shaking of the walls for more stable and steady baby room



Optional Extension Kit

- The baby room can be extended by adding each basic wall, wide wall, door wall and activity wall.
- The activity wall and melody wall will stimulate curiosity while enhancing concentration.
- Features a wall lock to be seated between two wall panels to minimize the shaking of the wall panels.

Basic Wall



Blue



Yellow

Activity Wall



Blue



Yellow

Door Wall



Blue



Yellow

Flat Connector & Melody Keyboard



Gray



Melody keyboard

Non-Slip Kit



Wall Lock



Non-slip Pad



Silicon Pad

* Colors may vary



Add a wall to your basic baby room to create a more spacious and diverse baby room.

Features



Double door lock system does not allow kids to open the door from inside.



Adorable character pictures are appealing and offer stability to the child. Character pictures can be changed upon request.



The square rubber pads are helpful to minimize the slipping of the walls.



Features a variety of kid's favorite melodies and lights and various activities, helpful for kids for their development of auditory sense and stimulating curiosity

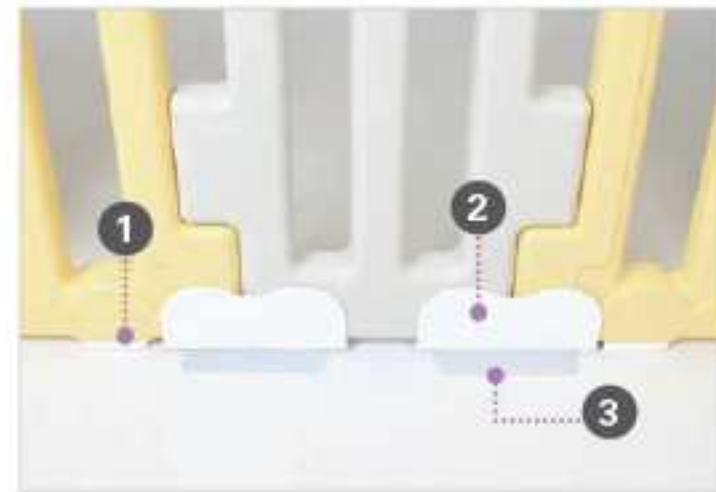

The additional Non-slip kit such as non-slip pad, wall lock and silicon pad to minimize the slipping and shaking of the walls for more stable and steady baby room



Optional Extension Kit

- The baby room can be extended by adding each basic wall, wide wall, door wall and activity wall.
- The activity wall and melody wall will stimulate curiosity while enhancing concentration.
- Features a wall lock to be seated between two wall panels to minimize the shaking of the wall panels.

Basic Wall



Blue



Yellow

Activity Wall



Blue



Yellow

Door Wall



Blue



Yellow

Flat Connector & Melody Keyboard



Gray



Melody keyboard

Non-Slip Kit



Wall Lock



Non-slip Pad



Silicon Pad

* Colors may vary

SIGNATURE & PETIT FOLDER MAT

Give your child a safe playzone with Signature Babyroom and Petit Baby Room matching with Signature & Petit Folder mat. The dual-sided colors can create its wide variety of moods. Non-toxic material are harmless to humans. It can also be used to transform into a sofa, used as a tunnel play, and an indoor sport arena.



 **Size**
L 1960 × W 1200 × H 40(T) mm
  **Box Size**
L 1240 × W 185 × H 510 mm
  **Weight**
3.70 kg
  **Material**
PU/PE
  **Age**
Over 0months



 **Size**
L 1400 × W 1400 × H 40(T) mm
  **Box Size**
L 1440 × W 90 × H 710 mm
  **Weight**
2.90 kg
  **Material**
PU/PE
  **Age**
Over 0months

Option ①

SIGNATURE FOLDER MAT for Signature Baby Room (2Colors)

HNM-801



Front



Back



Front

Option ②

PETIT FOLDER MAT for Petit Baby Room

HNM-802



Back

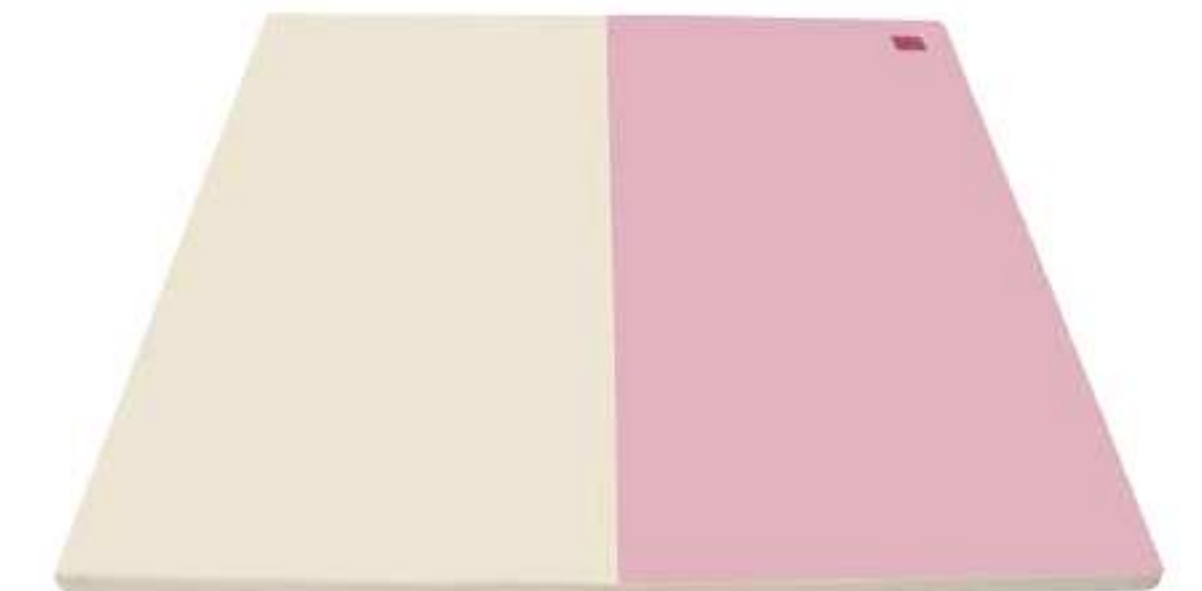

Front

Features



The material is made of safe, non-toxic PE material that is KC certified.



The zippers are internally hidden to prevent from child opening by an accident.



It has ability to absorb unwanted noise between floors with a 4cm thick PE foam material.



It is easily cleaned with a rag or a wipe.

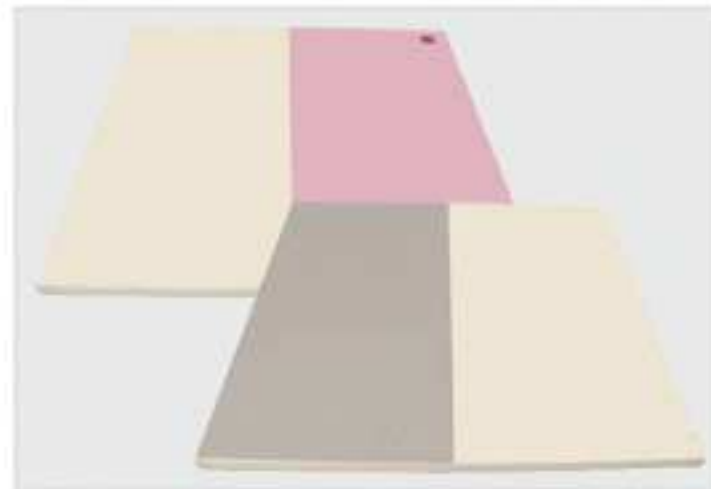

The different colors on each side offer a choice of ambience.



It is available for sofa, tunnel play, and indoor sport arena.



Application

Petit Baby Room



with Petit baby room gray 8pcs



with Petit baby room pink 8pcs

Signature Baby Room



with Signature baby room beige 6pcs



with Signature baby room blue 6pcs



with Signature baby room deep blue 6pcs



with Signature baby room yellow 6pcs



KIDS HOUSE & MY FIRST PLAYHOUSE

- Allows children of different ages to play together.
- Durable and sturdy construction.
- Open & close door.
- Ideal for group play.

Features



Working door.



Activity Center.



Opening window

KIDS HOUSE

HN-706

Size
L 1050 × W 970 × H 1190 mm

Box Size
L 1070 × W 400 × H 680 mm

Weight
170 kg

Material
PE/PP

Age
Over 36months



8 9 0 3 9 7 1 0 7 0 6 0 9



Red



NEW Navy

MY FIRST PLAYHOUSE

HN-705

Size
L 1440 × W 1050 × H 1190 mm

Box Size
L 1070 × W 480 × H 680 mm

Weight
22.5 kg

Material
PE/PP

Age
Over 36months



8 9 0 3 9 7 1 0 7 0 5 0 9



Red



NEW Navy



KIDS HOUSE WITH SLIDE & FUN PARK KIDS PLAYHOUSE

- Windows make it easy for kids to interact inside and outside of the play house.
- Working door.
- Made of high quality plastic, easy to assemble.
- Comes with fun park slide with basketball ring.

Features



Climber for young active adventurer.

Basketball ring.

Wavy slide for fun.

KIDS HOUSE WITH SLIDE

HN-778

Size
L 1700 × W 1540 × H 1190 mm

Box Size
L 1085 × W 510 × H 725 mm

Weight
21.8 kg

Material
PE/PP

Age
Over 36months



8 803971 000282



Red

NEW Navy

FUN PARK KIDS PLAYHOUSE

HN-777

Size
L 1700 × W 1540 × H 1190 mm

Box Size
L 1085 × W 510 × H 725 mm

Weight
24.3 kg

Material
PE/PP

Age
Over 36months



8 803971 000039



NEW Navy

Red



DOLPHIN SLIDE & DOLPHIN PLAY ZONE

- Durable and sturdy construction.
- Easy lock-together assembly with cap nuts.
- Comes with basketball game.
- Features Easy-grip handles for safety and a long wavy slide fun.

Features



Wide steps to a platform.



Basketball ring.



Wavy slide for fun.

DOLPHIN SLIDE

HNP-716

Size
L 1800 x W 550 x H 1080 mm

Box Size
1340 x W 310 x H 740 mm

Weight
12.6 kg

Material
PE/PP

Age
Over 24months



8 9 0 3 9 7 1 0 7 1 6 0 2



DOLPHIN PLAY ZONE

HNP-718

Size
L 1800 x W 1460 x H 1200 mm

Box Size
L 1350 x W 380 x H 740 mm

Weight
15.6 kg

Material
PP/PE/STEEL

Age
Over 24months



8 9 0 3 9 7 1 0 7 1 7 0 2





LITTLE SLIDE & LITTLE CASTLE

- Features a curved slide for sliding fun.
- Allows children of different ages to play together.
- Durable and sturdy construction.
- Easy lock-together assembly with nuts.
- Climber comes complete with a fun swing set extension.

Features



Curved slide for fun.



Climber for young active adventurer.



Basketball ring.

LITTLE SLIDE

HN-709N

Size
L 1050 × W 1000 × H 1010 mm

Box Size
1200 × W 370 × H 800 mm

Weight
12.5 kg

Material
PE/PP

Age
Over 24months



8 9 0 3 9 7 1 0 7 1 2 0 6



LITTLE CASTLE

HN-709

Size
L 1700 × W 1000 × H 1010 mm

Box Size
L 1200 × W 425 × H 800 mm

Weight
17.4 kg

Material
PP/PE

Age
Over 24months



8 9 0 3 9 7 1 0 7 0 9 0 2

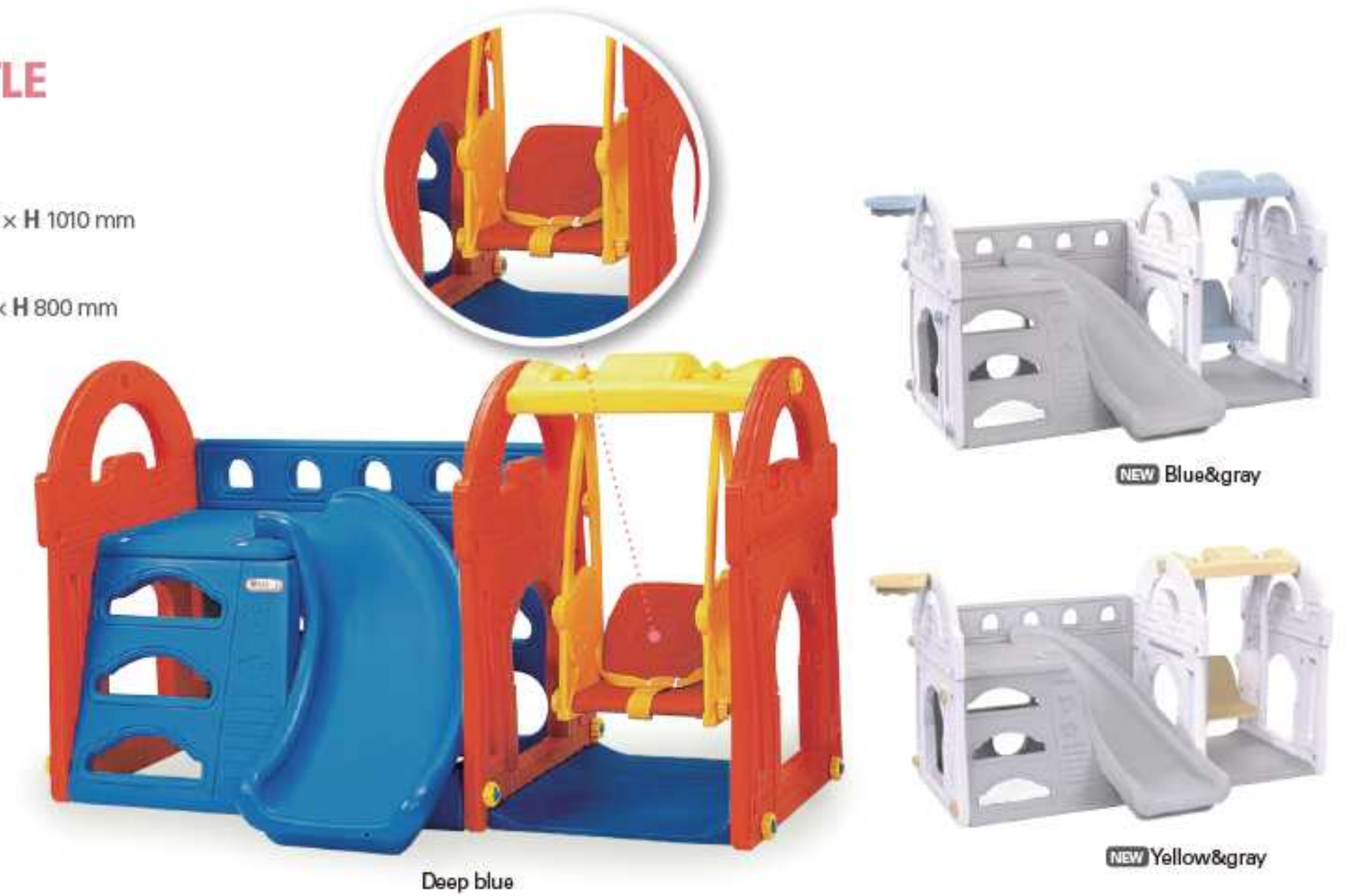



KIDS PLAY ZONE & KINGDOM PLAY ZONE

- Durable and sturdy construction.
- Easy lock-together assembly with nuts.
- Allows children of different ages to play together.
- Ideal for group play.



Waved slide for fun.



- My cozy and secret room under footrest



Fun swing set extension with a safety belt.

KIDS PLAY ZONE

HN-708

Size
L 1510 × W 1560 × H 1010 mm

Box Size
L 1020 × W 460 × H 770 mm

Weight
15 kg

Material
PE/PP

Age
Over 24months



8 9 0 3 9 7 1 0 7 0 8 0 3



NEW Blue&gray



NEW Yellow&gray



Deep blue

KINGDOM PLAY ZONE

HN-710

Size
L 2560 × W 1560 × H 1010 mm

Box Size
L 1210 × W 665 × H 805 mm

Weight
24.8 kg

Material
PP/PE

Age
Over 24months



8 9 0 3 9 7 1 0 7 1 1 0 7



NEW Blue&gray

NEW Yellow&gray



Deep blue

MY FIRST ACTIVITY SLIDE

- Easy to assemble with tube system.
- 3 platform are available as chair.
- Encourages keeping sense of balance in young toddlers.
- You can extend My First Activity Slide by adding extension kits for your active toddler.

HN-771

Size
L 1575 × W 1065 × H 715 mm

Box Size
L 1060 × W 385 × H 240 mm

Weight
6.7 kg

Material
PP/ABS

Age
Over 24months



8 803971 377100



NEW Pastel



The step is sized just right for young toddlers.



Ideally sized for young toddlers with a wavy slide.



NEW White

MINI COCO SLIDE

- Friendly Elephant with bright and tropical colors.
- Ideally sized for young toddlers with a wavy slide.
- Durable and sturdy construction.
- Easy lock-together assembly with cap nuts.

HN-717

Size
L 1500 × W 400 × H 730 mm

Box Size
L 965 × W 285 × H 740 mm

Weight
8.8 kg

Material
PP/PE

Age
Over 24months



8 803971 071701



NEW White



Wavy slide for young toddlers.



Wide platform for young toddlers.



Yellow

KIDZONE HN-707



- Playful climber offers climbing, crawling and sliding fun.
- Allows children of different ages to play together.
- Durable and sturdy construction.
- Easy lock-together assembly.
- Ideal for group play.



Wide platform leads to fun slide.

Two climbing walls for exciting adventure.

Size L 2420 × W 1010 × H 1240 mm
Box Size L 1190 × W 635 × H 1280 mm

Weight 33.5 kg **Material** LDPE **Age** Over 24months

PLAY HOUSE WITH A SWING DS-702A



- Play house comes complete with a fun swing set extension.
- Allows children of different ages to play together.
- Durable and sturdy construction.
- Easy lock-together assembly with nuts.
- Ideal for group play.



Kids friendly Snoopy.

Climbing wall

Size L 1580 × W 1340 × H 1030 mm
Box Size L 940 × W 380 × H 670 mm

Weight 13.5 kg **Material** PP/PE/STEEL **Age** Over 24months

LITTLE PLAY HOUSE DS-704



- Play house comes complete with a slide.
- Allows children of different ages to play together.
- Durable and sturdy construction.
- Open / close door.
- Easy lock-together assembly with nuts.
- Ideal for group play.



Slide and footrest

long slide for young toddlers.

Size L 1100 × W 1750 × H 1200 mm
Box Size L 1220 × W 480 × H 720 mm

Weight 175 kg **Material** PP/PE **Age** Over 24months

SUPER PLAY HOUSE WITH A SWING DS-703



- Play house comes complete with a slide.
- Allows children of different ages to play together.
- Durable and sturdy construction.
- Open / close door.
- Easy lock-together assembly with nuts.
- Ideal for group play.



Slide and footrest

Friendly giraffe for lovely toddlers.

Size L 1760 × W 1750 × H 1320 mm
Box Size L 1220 × W 520 × H 725 mm

Weight 24.2 kg **Material** PP/PE/STEEL **Age** Over 24months

HOUSE SLIDE HN-719



- Features a wide platform for safety and easy climb.
- Wavy slide for fun.
- Climber for young active adventurer.
- Working door for playing house inside.



Wide platform for safety.



Climber for young active adventurer.

TODDLER SLIDE HNP-715



- Friendly Elephant with bright and tropical colors.
- Features Easy-grip handles for safety and a long wavy slide fun.
- Durable and sturdy construction.
- Easy lock-together assembly with cap nuts.



Climber for young active adventurer.



Basketball game.

POPO SINGLE SWING DS-707



- Easy assembly.
- Simple & sophisticate design.



Swing seat with safety belt.



Foot rest for young toddlers.

POPO DOUBLE SWING DS-710



- Easy assembly.
- Simple & sophisticate design.
- Multipurpose swings with two swings seats.
- Available for a horizontal bar.



Wide foot rest for two toddlers.



Friendly giraffe for lovely toddlers.

Size L 2050 × W 710 × H 1200 mm
Box Size L 1025 × W 170 × H 990 mm (A)
L 1370 × W 180 × H 430 mm (B)

Weight 15 kg **Material** PP/PE **Age** Over 13months

Size L 1970 × W 860 × H 1320 mm
Box Size L 1030 × W 335 × H 690 mm

Weight 13.5 kg **Material** PP/PE **Age** Over 24months

Size L 1230 × W 910 × H 1200 mm
Box Size L 260 × W 260 × H 1160 mm

Weight 8.5 kg **Material** PP/PE/STEEL **Age** Over 24months

Size L 1280 × W 910 × H 1200 mm
Box Size L 360 × W 265 × H 1160 mm

Weight 10.9 kg **Material** PP/PE/STEEL **Age** Over 24months

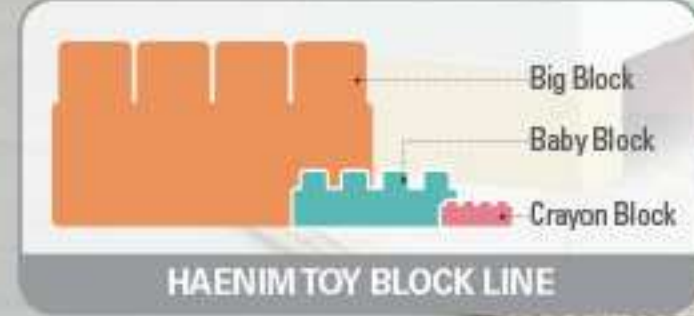

MACARON BIG BLOCK & CARRIE BIG BLOCK

- Encourage your children on their incredible journey of discovery.
- Help children develop their creativity, organizational skill and imagination.
- Real size building block.



Safe and harmless resin.



Inspires toddlers with their intellectual development.



Inspires toddlers with their physical activities while building blocks.

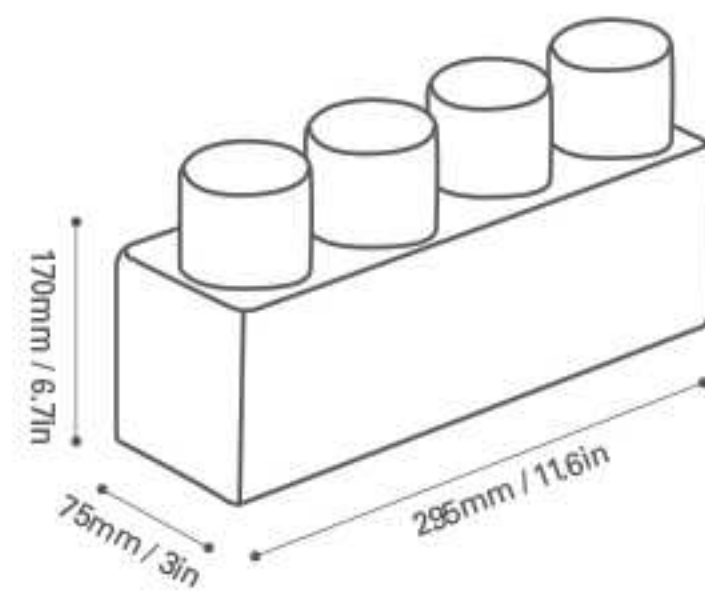

MACARON BIG BLOCK

28pcs HN-992 / 77pcs HN-993

Box Size
28pcs L 300 × W 530 × H 390 mm
77pcs L 370 × W 710 × H 520 mm

Weight
28pcs 7 kg / 77pcs 17 kg

Material
PP

Age
Over 6months

TOTAL
28pcs

TOTAL
77pcs

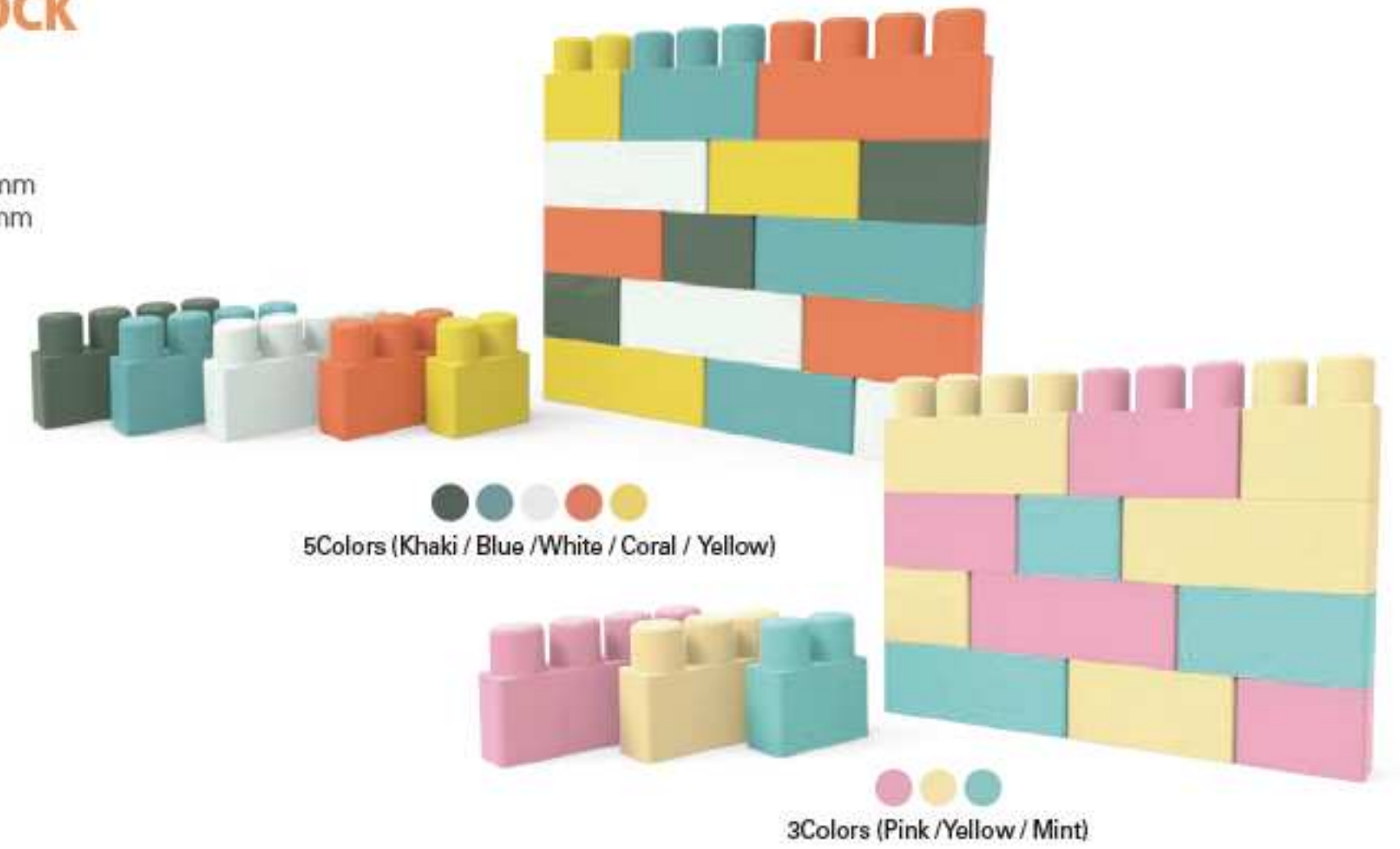

Macaron Big Block Optional Kit

- For more play fun, optional kit available like Door, Threshold, Roof, Table encourages your children on their incredible journey of discovery while creating Baby room, Airplane, Easel, Store.
- Help children develop their creativity, organizational skill and imagination.



Door



Roof



Threshold



Table



Baby room

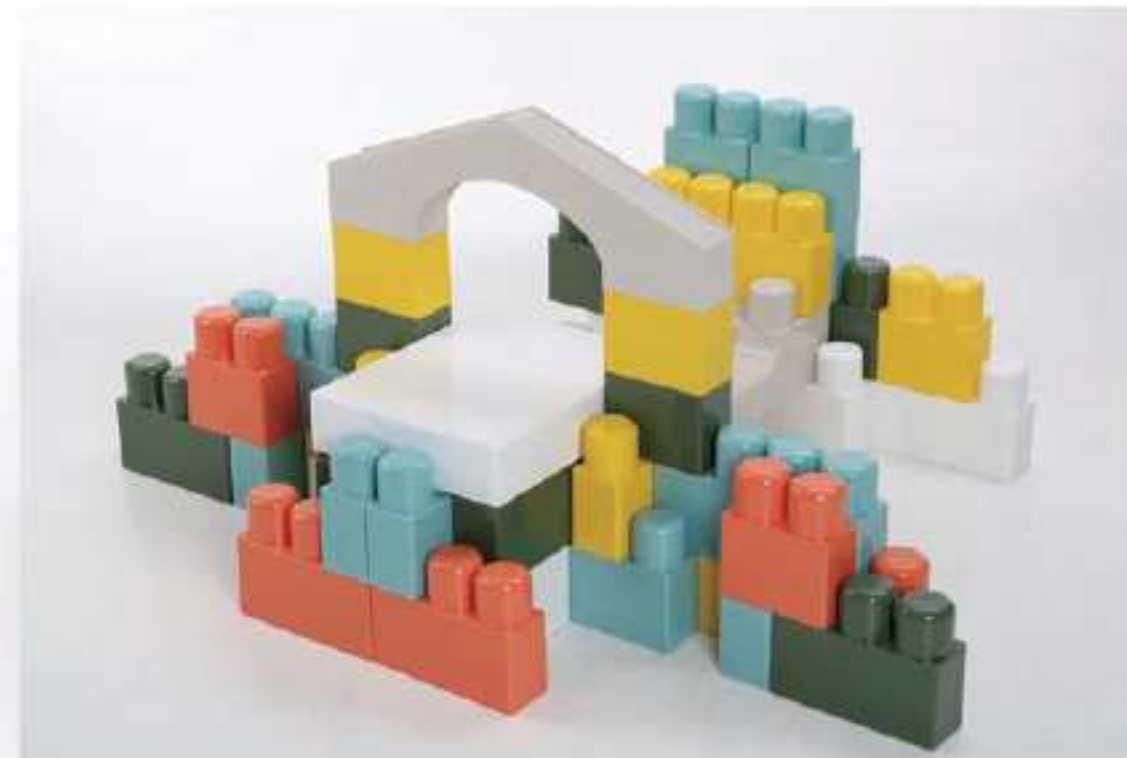

Airplane



Easel



Shop play

CARRIE BIG BLOCK

HN-994

Box Size
L 485 x W 620 x H 735 mm

Weight
22.6 kg

Material
PP/PE

Age
Over 6months



Optional Kit included

CARRIE FRIENDS

2018@carriesoft



5Colors (Yellow Green / Sky Blue / White / Pink / Orange)

TOTAL
89pcs



8 803971 000466



Desk



Shop play



Dressing table



Post office



Studio



Airplane

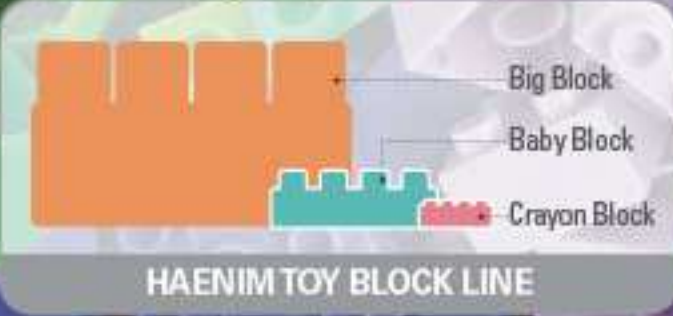

TOTAL
100 pcs

TOTAL
150 pcs

TOTAL
200 pcs

CRAYON BLOCK

- Encourage your children on their incredible journey of discovery.
- Help children develop their creativity, organizational skill and imagination.
- Compatible with other brands.
- For more building play, optional train set and playhouse set are available.

Color



Vivid



Pastel

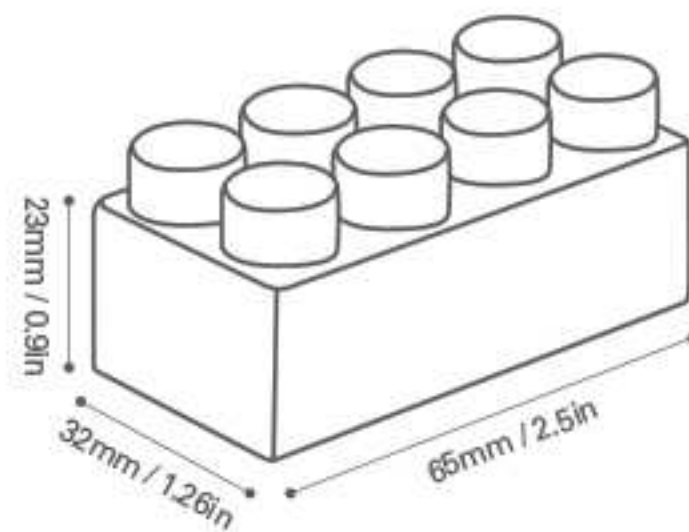

CRAYON BLOCK BASIC

HN-960

Box Size
L 230 x W 400 x H 290 mm

Weight
100pcs 1.12kg / 150pcs 1.8kg / 200pcs 2kg

Material
PP/ABS

Age
Over 36months



Option 1

TRAIN PLAY SET



Option 2

PLAYING HOUSE SET



Option 3

TOY BOX



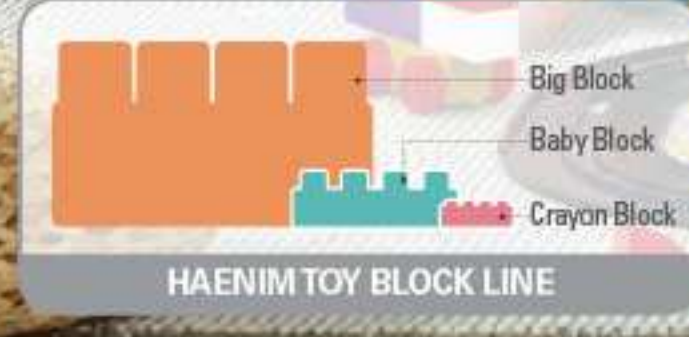

BABY BLOCK

- Ideally sized for young babies to grasp.
- Various animals.
- Use of non-toxic and harmless resin.
- Anti biostics silver-nano coating.



(Red / Yellow / Yellow green / blue / Purple / Pink / White)

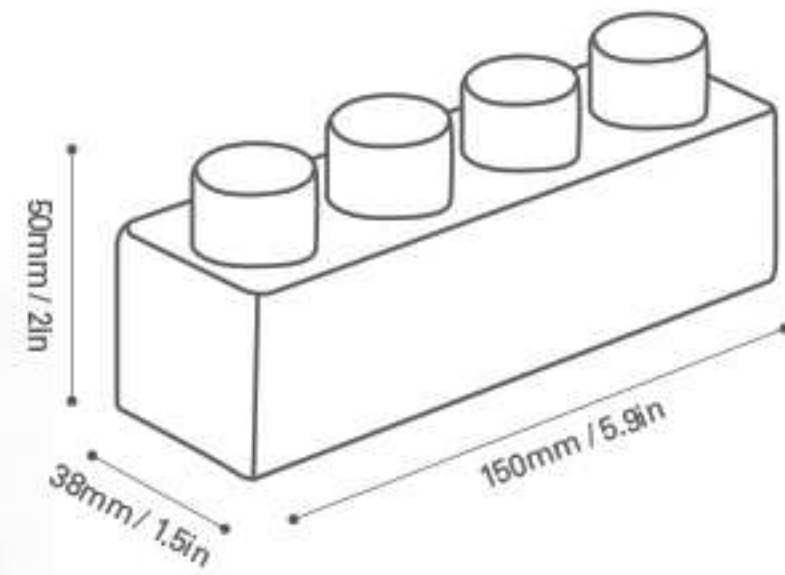

BABY BLOCK BASIC

HN-970B Standard pack : 3pcs/carton

Box Size
L 390 x W 220 x H 305 mm

Weight
2kg

Material
ABS

Age
Over 37months

TOTAL
86pcs



Option 2

TRAIN PLAYING BABY BLOCK

HN-972

TOTAL
130pcs

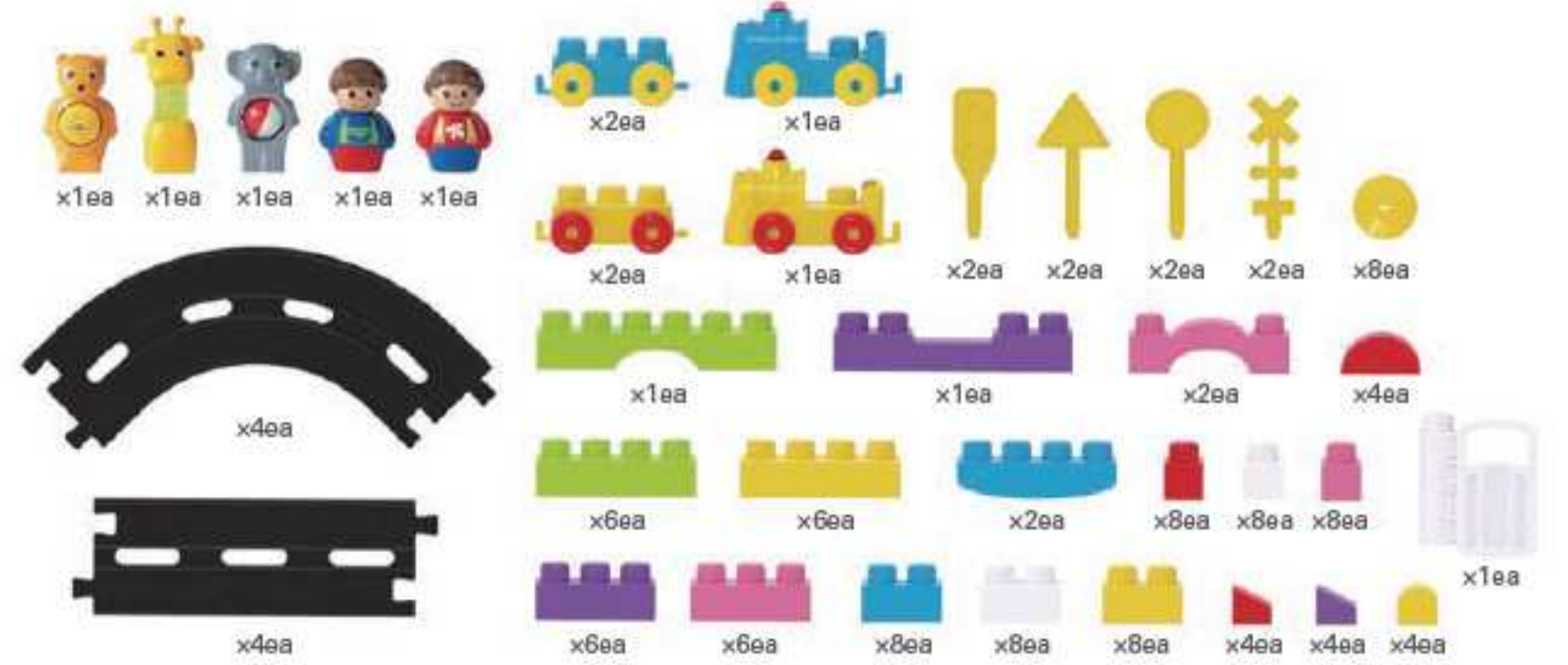

CARRIE MY CAR

- Sturdy and safe construction with parent assistant handle.
- Foot rest-option.
- Parent assist handle
- Removal roof for open car.

HN-255

Size
L 800 × W 570 × H 800 mm

Box Size
L 800 × W 470 × H 360 mm

Weight
6.4 kg

Material
PP/PE/STEEL

Age
Over 36months



Pink

Blue



Wing mirror



Steering wheel with working sounds.



Transforms into an open car!

ROYAL CAR SINGLE HNR-256 / DOUBLE HN-283



- Toddler car with foot-powered fun.
- Updated styling, colors and fun electronics.
- Features realistic, open/close door, roof and steering wheel with working sounds.
- Comfortable molded-in seat to sit on and a back storage.
- Sturdy and safe construction with parent assistant handle.



Single Lime



Double Red

Double Blue

Size Single L 740 × W 440 × H 990 mm / Double L 970 × W 460 × H 870 mm
Box Size Single L 850 × W 480 × H 550 mm / Double L 1050 × W 530 × H 625 mm

Weight Single 7.6 kg / Double 10.0 kg
Material PP/PE
Age Over 24months

DOLPHIN SEESAW HN-760



- Comfortable and safe riding with round molded design.
- Providing children with pleasant rocking fun.



Size L 1550 × W 290 × H 480 mm
Box Size L 1560 × W 295 × H 500 mm
Weight 4.7 kg
Material PE
Age Over 24months

ROCKING PONY HN-761



- Comfortable and safe riding with round molded design.
- Pleasant rocking activity horse.



Size L 870 × W 310 × H 480 mm
Box Size L 890 × W 320 × H 490 mm
Weight 3 kg
Material PE
Age Over 12months

BABY BATH TUB HN-302



Standard pack : 5pcs/carton

- Convenient for bathing your baby with non-slip base.



Removable, height adjustable headrest as your baby grows up.



Soap holder

Size L 700 × W 420 × H 225 mm
Box Size L 730 × W 460 × H 650 mm

Weight 1.5 kg **Material** PP/PE **Age** Over 0months

BABY BATH BED DS-303



Standard pack : 6pcs/carton

- Easy handling.
- Backrest with bassinet.



Green



Reclining backrest by adjusting length of strap.



Easy to adjust the angle

Size L 470 × W 330 × H 380 mm
Box Size L 700 × W 360 × H 615 mm

Weight 1.0 kg **Material** PP **Age** Over 0months

BIO TRAINER DS-803



- At the natural height for relaxing sitting.
- Round shaped plastic seat with an optional seat pad for comfort.
- Embossed foot rest.



Hand grip



Easy to empty by pulling the potty back

Size L 410 × W 320 × H 340 mm
Box Size L 415 × W 225 × H 325 mm

Weight 1.3 kg **Material** PP **Age** Over 12months

POTTY PLUS LEO DS-804N



- Multifunctional training potty that also doubles as a chair
- At the natural height for relaxing sitting.
- Round molded plastic for safety and comfort.
- Detachable deflector at the front of the bowl.



Playing board with different combinations of melodies and animal sounds.



Paper holder.

Size L 400 × W 460 × H 470 mm
Box Size L 422 × W 343 × H 330 mm

Weight 2.3 kg **Material** PP **Age** Over 12months

BABY BATH CHAIR HN-305



- Non-slip base.
- Reclining backrest.



Green



Beige



360° degree rotating bath chair.



Up&Down the bath chair

Size L 315 × W 290 × H 250 mm
Box Size L 300 × W 170 × H 390 mm

Weight 1.6 kg **Material** PP/PE **Age** Over 6months

AGA BED HN-337



- Easy to install and easy to use bed.
- Comfy, cozy and safety design.
- Brightly colored set makes bedtime fun time.



Guard Lock



Open & Close Guard

Size L 980 × W 700 × H 890 mm
Box Size L 810 × W 180 × H 980 mm

Weight 12 kg **Material** PP/PE **Age** Over 0months

SUNNY SWING BED DS-110



- Manually operated baby glider seat bed.
- Wheels for gliding and easy mobility.
- Convertible for rocking fun by folding wheels inside.
- Removable, washable seat pad.
- This glider offers gentle rocking from front to back to help soothe baby into a quiet state so he can drift off into slumber.



Yellow



Blue



Several position seat recline.



Removable plastic tray.

Size L 470 × W 750 × H 720 mm
Box Size L 895 × W 460 × H 360 mm

Weight 6.4 kg **Material** PP/PE/STEEL Fiber Sheet **Age** Over 0months

NEW HUGGIES BED HN-333



- Manually operated baby glider seat bed.
- Removable and washable seat pad.
- Wheels for gliding and easy mobility.
- Removable plastic tray.
- This glider offers gentle rocking from front to back to help soothe baby into a quiet state so he can drift off into slumber.



5-Point harness



4-position seat recline.

Size L 815 × W 500 × H 710 mm
Box Size L 880 × W 520 × H 410 mm

Weight 6.8 kg **Material** PP/PE/STEEL Fiber Sheet **Age** Over 0months

SINGLE DESK & CHAIR SET

- Ideally sized for young children.
- Easy assembly and movement.
- Lovely colors and design.

DS-906

Size
Desk Size L 650 × W 510 × H 540 mm
Chair Size L 340 × W 340 × H 600 mm

Box Size
L 690 × W 210 × H 600 mm

Weight
5.8 kg

Material
PP/PE

Age
Over 36months



8 903971 090412



Chair.



Drawer.



DOUBLE DESK & CHAIR SET

- Ideally sized for young children.
- Easy assembly and movement.
- Lovely colors and design.

DS-905

Size
Desk Size L 720 × W 670 × H 530 mm
Chair Size L 340 × W 340 × H 600 mm

Box Size
L 730 × W 280 × H 680mm

Weight
10.3 kg

Material
PP/PE

Age
Over 36months



8 903971 109050

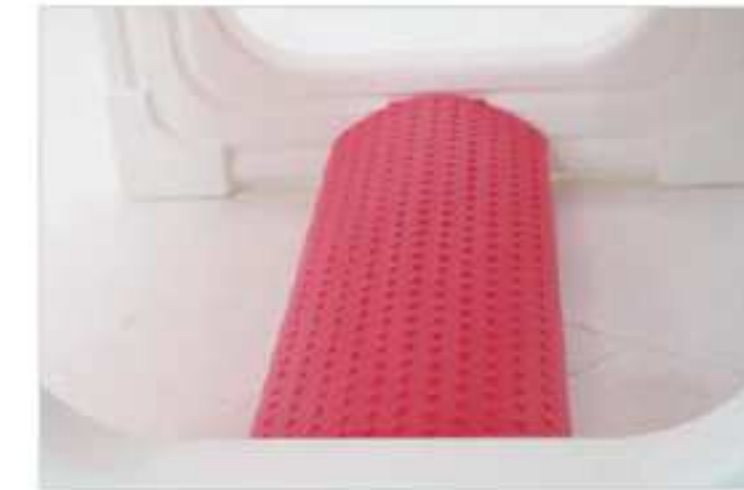

Footrest



Drawer and chair.



KIDS PLAY & PICNIC TABLE DS-908



- Quick & Easy to set up or takedown with capnuts.
- Seats up to 4 kids.



Portable, lightweight design for compact storage.



Useful for a picnic table, craft table, snack table or game table.

Size L 900 × W 795 × H 465 mm
Box Size L 920 × W 235 × H 515 mm

Weight 5.8 kg **Material** PE/ABS **Age** Over 24months

BEAR CHAIR HN-469



Standard pack : 6pcs/carton

- Cozy bear chair designed in a bright colors with smoothed corners and edges.
- Round molded seat for safety and comfort.



Cozy bear



Round molded-in chair leg for safety.

Size L 360 × W 300 × H 520 mm
Box Size L 900 × W 520 × H 580 mm

Weight 1.7 kg **Material** PE **Age** Over 12months



CHARACTER ZONE

CARRIE FRIENDS



CARRIE PLAY ROOM (Pink)



CARRIE PLAY ROOM (Blue)



CARRIE MY CAR



KEVIN MY CAR



CARRIE BIG BLOCK



CARRIE BALL



KEVIN BALL